



Haas Automation, Inc.

Lathe Auto Parts Loader Operator's Manual Supplement

Next Generation Control
96-8040
Revision C
May 2020
English
Original Instructions

Haas Automation Inc.
2800 Sturgis Road
Oxnard, CA 93030-8933
U.S.A. | HaasCNC.com

© 2020 Haas Automation, Inc.

All rights reserved. No part of this publication may be reproduced, stored in a retrieval system, or transmitted, in any form, or by any means, mechanical, electronic, photocopying, recording, or otherwise, without the written permission of Haas Automation, Inc. No patent liability is assumed with respect to the use of the information contained herein. Moreover, because Haas Automation strives constantly to improve its high-quality products, the information contained in this manual is subject to change without notice. We have taken every precaution in the preparation of this manual; nevertheless, Haas Automation assumes no responsibility for errors or omissions, and we assume no liability for damages resulting from the use of the information contained in this publication.



This product uses Java Technology from Oracle Corporation and we request that you acknowledge that Oracle owns the Java Trademark and all Java related Trademarks and agree to comply with the trademark guidelines at www.oracle.com/us/legal/third-party-trademarks/index.html.

Any further distribution of the Java programs (beyond this appliance/machine) is subject to a legally binding End User License Agreement with Oracle. Any use of the commercial features for production purposes requires a separate license from Oracle.

LIMITED WARRANTY CERTIFICATE

Haas Automation, Inc.

Covering Haas Automation, Inc. CNC Equipment

Effective September 1, 2010

Haas Automation Inc. (“Haas” or “Manufacturer”) provides a limited warranty on all new mills, turning centers, and rotary machines (collectively, “CNC Machines”) and their components (except those listed below under Limits and Exclusions of Warranty) (“Components”) that are manufactured by Haas and sold by Haas or its authorized distributors as set forth in this Certificate. The warranty set forth in this Certificate is a limited warranty, it is the only warranty by Manufacturer, and is subject to the terms and conditions of this Certificate.

Limited Warranty Coverage

Each CNC Machine and its Components (collectively, “Haas Products”) are warranted by Manufacturer against defects in material and workmanship. This warranty is provided only to an end-user of the CNC Machine (a “Customer”). The period of this limited warranty is one (1) year. The warranty period commences on the date the CNC Machine is installed at the Customer’s facility. Customer may purchase an extension of the warranty period from an authorized Haas distributor (a “Warranty Extension”), any time during the first year of ownership.

Repair or Replacement Only

Manufacturer’s sole liability, and Customer’s exclusive remedy under this warranty, with respect to any and all Haas products, shall be limited to repairing or replacing, at the discretion of the Manufacturer, the defective Haas product.

Disclaimer of Warranty

This warranty is Manufacturer’s sole and exclusive warranty, and is in lieu of all other warranties of whatever kind or nature, express or implied, written or oral, including, but not limited to, any implied warranty of merchantability, implied warranty of fitness for a particular purpose, or other warranty of quality or performance or noninfringement. All such other warranties of whatever kind are hereby disclaimed by Manufacturer and waived by Customer.

Limits and Exclusions of Warranty

Components subject to wear during normal use and over time, including, but not limited to, paint, window finish and condition, light bulbs, seals, wipers, gaskets, chip removal system (e.g., augers, chip chutes), belts, filters, door rollers, tool changer fingers, etc., are excluded from this warranty. Manufacturer's specified maintenance procedures must be adhered to and recorded in order to maintain this warranty. This warranty is void if Manufacturer determines that (i) any Haas Product was subjected to mishandling, misuse, abuse, neglect, accident, improper installation, improper maintenance, improper storage, or improper operation or application, including the use of improper coolants or other fluids, (ii) any Haas Product was improperly repaired or serviced by Customer, an unauthorized service technician, or other unauthorized person, (iii) Customer or any person makes or attempts to make any modification to any Haas Product without the prior written authorization of Manufacturer, and/or (iv) any Haas Product was used for any non-commercial use (such as personal or household use). This warranty does not cover damage or defect due to an external influence or matters beyond the reasonable control of Manufacturer, including, but not limited to, theft, vandalism, fire, weather condition (such as rain, flood, wind, lightning, or earthquake), or acts of war or terrorism.

Without limiting the generality of any of the exclusions or limitations described in this Certificate, this warranty does not include any warranty that any Haas Product will meet any person's production specifications or other requirements, or that operation of any Haas Product will be uninterrupted or error-free. Manufacturer assumes no responsibility with respect to the use of any Haas Product by any person, and Manufacturer shall not incur any liability to any person for any failure in design, production, operation, performance, or otherwise of any Haas Product, other than repair or replacement of same as set forth in the warranty above.

Limitation of Liability and Damages

Manufacturer will not be liable to Customer or any other person for any compensatory, incidental, consequential, punitive, special, or other damage or claim, whether in an action in contract, tort, or other legal or equitable theory, arising out of or related to any Haas product, other products or services provided by Manufacturer or an authorized distributor, service technician, or other authorized representative of Manufacturer (collectively, "authorized representative"), or the failure of parts or products made by using any Haas Product, even if Manufacturer or any authorized representative has been advised of the possibility of such damages, which damage or claim includes, but is not limited to, loss of profits, lost data, lost products, loss of revenue, loss of use, cost of down time, business good will, any damage to equipment, premises, or other property of any person, and any damage that may be caused by a malfunction of any Haas product. All such damages and claims are disclaimed by Manufacturer and waived by Customer. Manufacturer's sole liability, and Customer's exclusive remedy, for damages and claims for any cause whatsoever shall be limited to repair or replacement, at the discretion of Manufacturer, of the defective Haas Product as provided in this warranty.

Customer has accepted the limitations and restrictions set forth in this Certificate, including, but not limited to, the restriction on its right to recover damages, as part of its bargain with Manufacturer or its Authorized Representative. Customer realizes and acknowledges that the price of the Haas Products would be higher if Manufacturer were required to be responsible for damages and claims beyond the scope of this warranty.

Entire Agreement

This Certificate supersedes any and all other agreements, promises, representations, or warranties, either oral or in writing, between the parties or by Manufacturer with respect to subject matter of this Certificate, and contains all of the covenants and agreements between the parties or by Manufacturer with respect to such subject matter. Manufacturer hereby expressly rejects any other agreements, promises, representations, or warranties, either oral or in writing, that are in addition to or inconsistent with any term or condition of this Certificate. No term or condition set forth in this Certificate may be modified or amended, unless by a written agreement signed by both Manufacturer and Customer. Notwithstanding the foregoing, Manufacturer will honor a Warranty Extension only to the extent that it extends the applicable warranty period.

Transferability

This warranty is transferable from the original Customer to another party if the CNC Machine is sold via private sale before the end of the warranty period, provided that written notice thereof is provided to Manufacturer and this warranty is not void at the time of transfer. The transferee of this warranty will be subject to all terms and conditions of this Certificate.

Miscellaneous

This warranty shall be governed by the laws of the State of California without application of rules on conflicts of laws. Any and all disputes arising from this warranty shall be resolved in a court of competent jurisdiction located in Ventura County, Los Angeles County, or Orange County, California. Any term or provision of this Certificate that is invalid or unenforceable in any situation in any jurisdiction shall not affect the validity or enforceability of the remaining terms and provisions hereof, or the validity or enforceability of the offending term or provision in any other situation or in any other jurisdiction.

Customer Feedback

If you have concerns or questions regarding this Operator's Manual, please contact us on our website, www.HaasCNC.com. Use the "Contact Us" link and send your comments to the Customer Advocate.

Join Haas owners online and be a part of the greater CNC community at these sites:



haasparts.com
Your Source for Genuine Haas Parts



www.facebook.com/HaasAutomationInc
Haas Automation on Facebook



www.twitter.com/Haas_Automation
Follow us on Twitter



www.linkedin.com/company/haas-automation
Haas Automation on LinkedIn



www.youtube.com/user/haasautomation
Product videos and information



www.flickr.com/photos/haasautomation
Product photos and information

Customer Satisfaction Policy

Dear Haas Customer,

Your complete satisfaction and goodwill are of the utmost importance to both Haas Automation, Inc. and the Haas distributor (HFO) where you purchased your equipment. Normally, your HFO will rapidly resolve any concerns you have about your sales transaction or the operation of your equipment.

However, if your concerns are not resolved to your complete satisfaction, and you have discussed your concerns with a member of the HFO's management, the General Manager, or the HFO's owner directly, please do the following:

Contact Haas Automation's Customer Service Advocate at 805-988-6980. So that we may resolve your concerns as quickly as possible, please have the following information available when you call:

- Your company name, address, and phone number
- The machine model and serial number
- The HFO name, and the name of your latest contact at the HFO
- The nature of your concern

If you wish to write Haas Automation, please use this address:

Haas Automation, Inc. U.S.A.
2800 Sturgis Road
Oxnard CA 93030
Att: Customer Satisfaction Manager
email: customerservice@HaasCNC.com

Once you contact the Haas Automation Customer Service Center, we will make every effort to work directly with you and your HFO to quickly resolve your concerns. At Haas Automation, we know that a good Customer-Distributor-Manufacturer relationship will help ensure continued success for all concerned.

International:

Haas Automation, Europe
Mercuriusstraat 28, B-1930
Zaventem, Belgium
email: customerservice@HaasCNC.com

Haas Automation, Asia
No. 96 Yi Wei Road 67,
Waigaoqiao FTZ
Shanghai 200131 P.R.C.
email: customerservice@HaasCNC.com



Declaration of Incorporation

Product: Automatic Parts Loader

Serial Number: _____

Manufactured By: Haas Automation, Inc.

2800 Sturgis Road, Oxnard, CA 93030 **805-278-1800**

We declare, in sole responsibility, that the above listed product, to which this declaration refers, cannot function independently and does not change the function of the machine it is attached to. The Automatic Parts Loader, when incorporated into Haas CNC Lathes (turning centers) or VMC (vertical machining center), complies with the regulations as outlined in the CE directive for machinery:

- Machinery Directive 2006 / 42 / EC
- Electromagnetic Compatibility Directive 2014 / 30 / EU
- Additional Standards:
 - EN 60204-1:2006 / A1:2009
 - EN 614-1:2006+A1:2009
 - EN 894-1:1997+A1:2008
 - EN ISO 13849-1:2015

RoHS2: COMPLIANT (2011/65/EU) by Exemption per producer documentation.

Exempt by:

- a) Large scale stationary industrial tool.
- b) Lead as an alloying element in steel, aluminum, and copper.
- c) Cadmium and its compounds in electrical contacts.

Person authorized to compile technical file:

Jens Thing

Address:

Haas Automation Europe
Mercuriusstraat 28
B-1930 Zaventem
Belgium

USA: Haas Automation certifies this machine to be in compliance with the OSHA and ANSI design and manufacturing standards listed below. Operation of this machine will be compliant with the below-listed standards only as long as the owner and operator continue to follow the operation, maintenance, and training requirements of these standards.

- *OSHA 1910.212 - General Requirements for All Machines*
- *ANSI B11.5-1984 (R1994) Lathes*
- *ANSI B11.19-2010 Performance Criteria for Safeguarding*
- *ANSI B11.22-2002 Safety Requirements for Turning Centers and Automatic Numerically Controlled Turning Machines*
- *ANSI B11.TR3-2000 Risk Assessment and Risk Reduction - A Guideline to Estimate, Evaluate, and Reduce Risks Associated with Machine Tools*

CANADA: As the original equipment manufacturer, we declare that the listed products comply with regulations as outlined in the Pre-Start Health and Safety Reviews Section 7 of Regulation 851 of the Occupational Health and Safety Act Regulations for Industrial Establishments for machine guarding provisions and standards.

Further, this document satisfies the notice-in-writing provision for exemption from Pre-Start inspection for the listed machinery as outlined in the Ontario Health and Safety Guidelines, PSR Guidelines dated November 2016. The PSR Guidelines allow that notice in writing from the original equipment manufacturer declaring conformity to applicable standards is acceptable for the exemption from Pre-Start Health and Safety Review.



All Haas CNC machine tools carry the ETL Listed mark, certifying that they conform to the NFPA 79 Electrical Standard for Industrial Machinery and the Canadian equivalent, CAN/CSA C22.2 No. 73. The ETL Listed and cETL Listed marks are awarded to products that have successfully undergone testing by Intertek Testing Services (ITS), an alternative to Underwriters' Laboratories.



Haas Automation has been assessed for conformance with the provisions set forth by ISO 9001: 2015. Scope of Registration: Design and Manufacture of CNC Machines Tools and Accessories, Sheet Metal Fabrication. The conditions for maintaining this certificate of registration are set forth in ISA's Registration Policies 5.1. This registration is granted subject to the organization maintaining compliance to the noted standard. The validity of this certificate is dependent upon ongoing surveillance audits.

Original Instructions

User's Operator Manual and other Online Resources

This manual is the operation and programming manual that applies to all Haas Lathes.

An English language version of this manual is supplied to all customers and is marked "**Original Instructions**".

For many other areas of the world, there is a translation of this manual marked "**Translation of Original Instructions**".

This manual contains an unsigned version of the EU required "**Declaration Of Conformity**". European customers are provided a signed English version of the Declaration of Conformity with Model Name and Serial Number.

Besides this manual, there is a tremendous amount of additional information online at: www.haascnc.com under the Service section.

Both this manual and the translations of this manual are available online for machines up to approximately 15 years old.

The CNC control of your machine also contains all of this manual in many languages and can be found by passing the **[HELP]** button.

Many machine models come with manual supplement that is also available online.

All machine options also have additional information online.

Maintenance and service information is available online.

The online "**Installation Guide**" contains information and check list for Air & Electrical requirements, Optional Mist Extractor, Shipping Dimensions, weight, Lifting Instructions, foundation and placement, etc.

Guidance on proper coolant and Coolant Maintenance is located in the Operators Manual and Online.

Air and Pneumatic diagrams are located on the inside of the lubrication panel door and CNC control door.

Lubrication, grease, oil and hydraulic fluid types are listed on a decal on the machine's lubrication panel.





How to Use This Manual

To get the maximum benefit of your new Haas machine, read this manual thoroughly and refer to it often. The content of this manual is also available on your machine control under the HELP function.

IMPORTANT: Before you operate the machine, read and understand the Operator's Manual Safety chapter.

Declaration of Warnings

Throughout this manual, important statements are set off from the main text with an icon and an associated signal word: "Danger," "Warning," "Caution," or "Note." The icon and signal word indicate the severity of the condition or situation. Be sure to read these statements and take special care to follow the instructions.

Description	Example
<p>Danger means that there is a condition or situation that will cause death or severe injury if you do not follow the instructions given.</p>	 <p>DANGER: No step. Risk of electrocution, bodily injury, or machine damage. Do not climb or stand on this area.</p>
<p>Warning means that there is a condition or situation that will cause moderate injury if you do not follow the instructions given.</p>	 <p>WARNING: Never put your hands between the tool changer and the spindle head.</p>
<p>Caution means that minor injury or machine damage could occur if you do not follow the instructions given. You may also have to start a procedure over if you do not follow the instructions in a caution statement.</p>	 <p>CAUTION: Power down the machine before you do maintenance tasks.</p>
<p>Note means that the text gives additional information, clarification, or helpful hints.</p>	 <p>NOTE: Follow these guidelines if the machine is equipped with the optional extended Z-clearance table.</p>

Text Conventions Used in this Manual

Description	Text Example
A Code Block text gives program examples.	G00 G90 G54 X0. Y0. ;
A Control Button Reference gives the name of a control key or button that you are to press.	Press [CYCLE START] .
A File Path describes a sequence of file system directories.	<i>Service > Documents and Software >...</i>
A Mode Reference describes a machine mode.	MDI
A Screen Element describes an object on the machine's display that you interact with.	Select the SYSTEM tab.
A System Output describes text that the machine control displays in response to your actions.	PROGRAM END
A User Input describes text that you should enter into the machine control.	G04 P1. ;
A Variable n indicates a range of non-negative integers from 0 to 9.	Dnn represents D00 through D99.

Contents

	User's Operator Manual and other Online Resources	xi
	How to Use This Manual	xii
Chapter 1	APL Introduction	1
	1.1 APL Introduction	1
	1.2 APL - Overview	2
	1.3 APL - Specifications	3
Chapter 2	APL Installation	11
	2.1 Lathe APL - Installation	11
Chapter 3	APL Operation.	13
	3.1 APL Settings.	13
	3.1.1 372 - Parts Loader Type	13
	3.1.2 375 - APL Gripper Type	13
	3.1.3 376 - Light Curtain Enable	13
	3.2 Jog the APL	14
	3.3 APL Setup	15
	3.3.1 Automatic Part Loader - Template	15
	3.3.2 Automatic Part Loader - Load Part	16
	3.3.3 Automatic Part Loader - Unload Part	18
	3.3.4 Automatic Part Loader - APL Mode - Save/Load/New Job	21
	3.4 APL Recovery	24
Chapter 4	APL Programming	25
	4.1 M299 APL / Part Load / or Program End	25
	4.2 Plunger Programming	26
	4.3 APL Stop/Resume Feature	27
Chapter 5	APL Maintenance	29
	5.1 APL Maintenance	29
	Index	31



Chapter 1: APL Introduction

1.1 APL Introduction

This manual outlines the unique features and functions of the Automatic Parts Loader. Refer to your Lathe Operator's Manual for control operation, programming, and other general lathe information.

F1.1: Automatic Parts Loader (APL)



APL installation instructions can be found on www.haascnc.com under the service section.



CAUTION:

Only authorized and trained personnel may operate this equipment. You must always act in accordance with the Operator's manual, safety decals, safety procedures and instructions for safe machine operation. Untrained personnel present a hazard to themselves and the machine.



CAUTION:

Do not operate this machine until you have read all warnings, cautions, and instructions.

1.2 APL - Overview

F1.2: APL Overview Diagram.

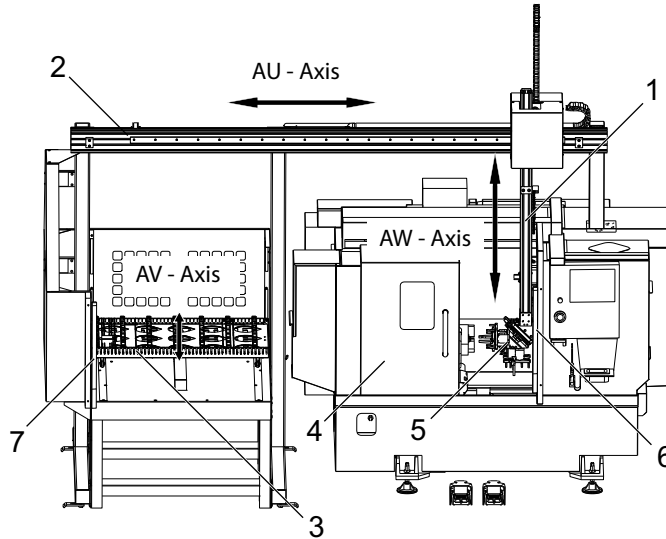

1. AW-Axis [1] this axis moves the ram up and down.
2. AU-Axis [2] this axis moves across the ram left to right.
3. AV-Axis [3] this axis moves the table front to back.
4. Auto door
5. Grippers
6. Light Curtain Sensor
7. Light Curtain Sensor



NOTE:

The APL is equipped with a light curtain sensor, which will stop the APL motion any time it senses the operator moved into the light curtain zone. If a program is running it will not be interrupted by the light curtain. [CYCLE START] will continue APL motion.

1.3 APL - Specifications

T1.1: APL Specifications

	Inch	Metric
Axis Travels (AU, AV, AW)	111" x 28" x 46"	2819 x 711 x 1168 mm
Rapids (AU)	1417 in/min	36 m/min
Rapids (AV)	118 in/min	3 m/min
Rapids (AW)	1417 in/min	36 m/min
Maximum Part (Diameter x Length)	5.8" x 5.0"	147 x 127 mm
Maximum Part Weight Per Gripper	10 lb	4.5 kg
Table Size (Length x Width)	48" x 28"	1219 x 711 mm
Table Load Capacity	1000 lb	454 kg
Gripper Rotation	90°	90°

Part Size Specifications

F1.3: Slug Maximum Part Size

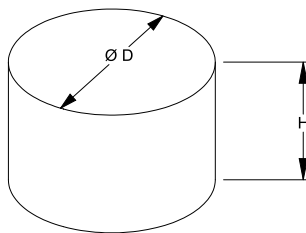

T1.2: Slug Maximum Part Size

Specification	ST-10/15	ST-20/25
Height (H)	Less than or equal to 5.0 in (127 mm)	Less than or equal to 5.0 in (127 mm) *see note
Diameter (D)	Less than or equal to 5.8 in (147 mm)	Less than or equal to 5.8 in (147 mm)
Weight	Less than or equal 10 lbs (4.6 kg) Per Part	



NOTE:

When indexing between the finished and raw part grippers during reloading, long parts may require the gantry to index over the APL table.

F1.4: Bar Maximum Part Size

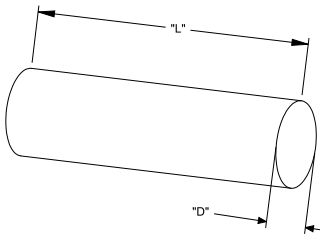

T1.3: Bar Maximum Part Size

Specification	ST-10/15	ST-20/25
Length (L)	Less than or equal to 6.0 in (152 mm)	Less than or equal to 8.0 in (203 mm)
Diameter (D)	Less than or equal to 4.0 in (102 mm)	Less than or equal to 4.0 in (102 mm)
Weight	Less than or equal 10 lbs (4.6 kg) Per Part	

IMPORTANT: Depending on the machine size, turret style, and part-specific tooling used, 1 - 3 turret stations may be required to be empty to allow Gantry clearance. Please review your specific application with an Application Engineer at your local HFO if there is any doubt regarding your application's compatibility.

Standard Bar Templates

F1.5: Standard Slug Templates

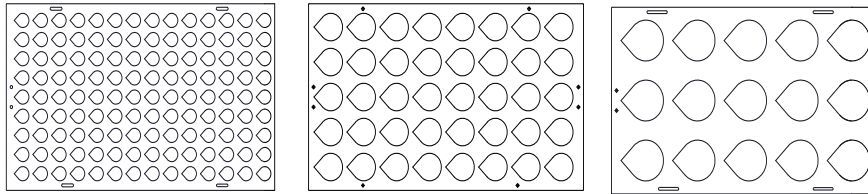

Small

Medium

Large

T1.4: Standard Slug Templates

Template	Diameter Range	Rows	Columns	Maximum Parts
Small	0.97 - 2.1 in (24.6 - 53.3 mm)	9	14	126
Medium	2.0 - 4.1 in (50 - 104 mm)	5	8	40
Large	4.0 - 5.0 in (100 - 150 mm)	3	5	15

F1.6: Custom Slug Templates

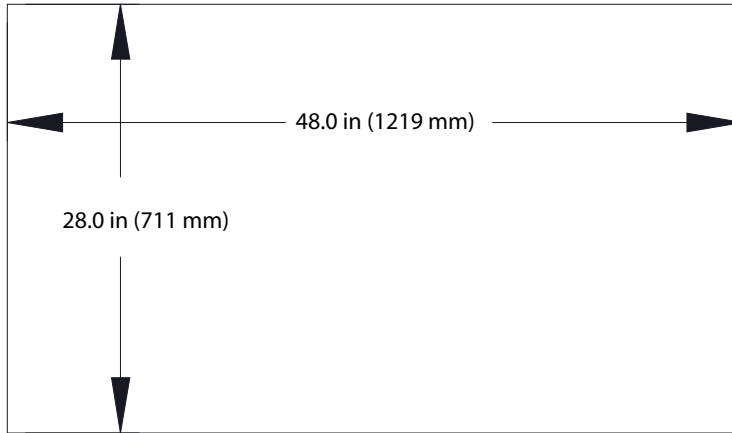

Custom templates can be made by the user with the following requirements:

1. Allow adequate space between rows and columns for gripper clearance.
2. All rows must have equal spacing.
3. All columns must have equal spacing (but can be different than row spacing).

F1.7: Puck Grippers Specifications

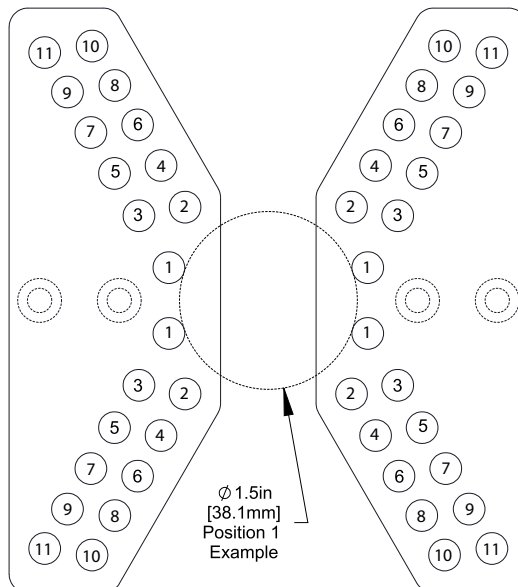

T1.5: Puck Grippers Specifications

Position	Min Diameter (Inch)	Max Diameter (Inch)	Min Diameter (Metric)	Max Diameter (Metric)
1	0.97	1.69	24.6	42.9
2	1.66	2.1	42.2	53.3
3	2.06	2.68	52.3	68.1
4	2.61	3.03	66.3	76.9
5	3	3.56	76.2	90.4
6	3.53	3.95	89.7	100.3
7	3.92	4.45	99.6	113
8	4.43	4.84	112.5	112.9
9	4.83	5.34	122.7	135.6
10	5.33	5.74	135.4	145.8
11	5.72	6.22	145.3	158

F1.8: Standard Bar Templates - Side / Row View

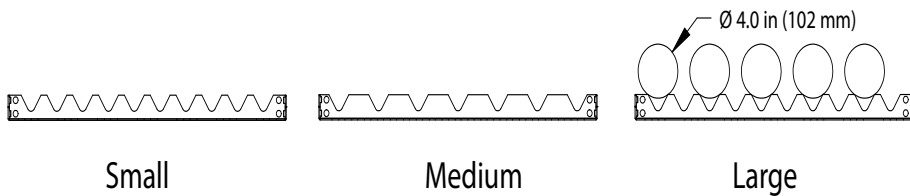

T1.6: Standard Bar Templates

Template	Diameter Range	Length Range	Rows	Columns
Small	0.85 - 1.5 in (21.6 - 38.1 mm)	ST-10 9.0-16.0 in (228-406 mm)	10	Varies with length
Medium	1.5 - 2.75 in (38.1 - 70 mm)	ST-15 6.0-16.0 in (152-406 mm)	7	
Large Uses the small bar template. Skips every other row.	2.75 - 4.0 in (70 - 102 mm)	ST-20 6.0-21.0 in (152-533 mm) ST-25 5.0-21.0 in (127-533 mm) Limited by Weight	5	

F1.9: Finger Grippers Specifications - The position specifies the inner hole [1] of the gripper fingers.

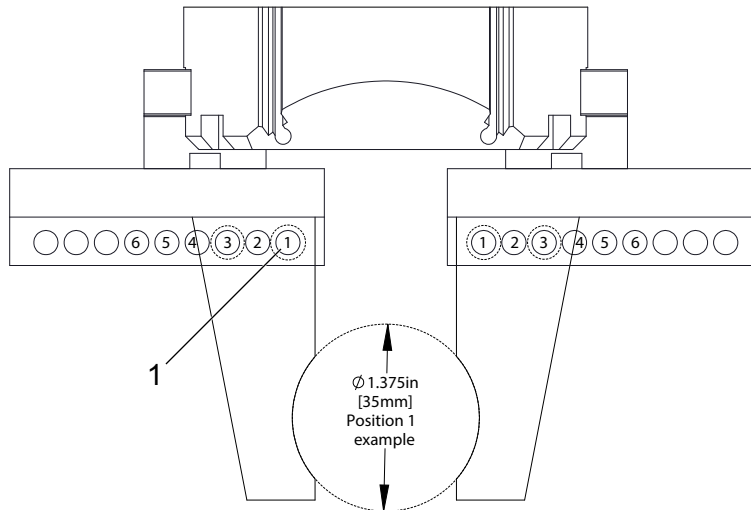

T1.7: Finger Grippers Specifications

Position	Min Diameter (Inch)	Max Diameter (Inch)	Min Diameter (Metric)	Max Diameter (Metric)
1	0.848	1.522	23.5	38.6
2	1.464	2.147	37.2	54.4
3	2.081	2.772	52.9	70.4
4	2.697	3.397	68.5	86.3
5	3.314	4.022	84.2	102.1
6	3.93	4.647	99.8	118.1

F1.10: Recommended Gripper Swap Safe Locations

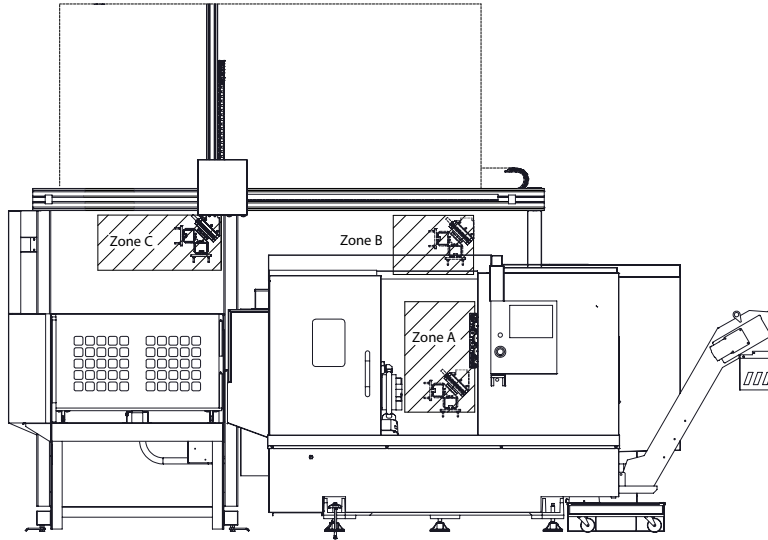

The APL can rotate from the Raw gripper to the Finished gripper in 3 zones - A, B or C. Choose a rotate zone that does not interfere with any machine components.

APL Gripper Rotate Zones

Zone A- Inside Machine

Zone B- Above Door (ST-10 / ST-15 only)

Zone C - Over APL Table

Chapter 2: APL Installation

2.1 Lathe APL - Installation

The Lathe APL installation procedure is located on the website click on the following link: [Haas Automatic Parts Loader - Lathe - Installation](#). You can also scan the code below with your mobile device to go directly to the procedure.



Chapter 3: APL Operation

3.1 APL Settings

The following settings affect how the APL operates.

3.1.1 372 - Parts Loader Type

This setting turns on the Automatic Parts Loader (APL) in **[CURRENT COMMANDS]** under the Devices tab. Use this page to set up the APL.



DANGER:

*If you turn this setting **[OFF]**, the AW - axis will drop if not supported or disconnected. Do one of the following:*

- Jog to a safe location
- Unplug all APL cables **BEFORE** releasing E-STOP
- Unplug AW brake **BEFORE** releasing E-STOP

3.1.2 375 - APL Gripper Type

This setting chooses the type of gripper attached to the Automatic Parts Loader (APL).

APL Gripper has the functionality of gripping raw and finished parts on an outer diameter or inner diameter, in addition to being able to swap between them.

3.1.3 376 - Light Curtain Enable

This setting enables the Light Curtain. When the Light Curtain is enabled, it will prevent APL motion if it detects something in an area too close to the APL axes.

If the light curtain beam is obstructed the machine will go into a Light Curtain Hold condition; the CNC program will continue to run and the machine's spindle and axes will continue to move but the AU, AV and AW axes will not move. The machine will remain in Light Curtain Hold until the light curtain beam is unobstructed and the Cycle Start button is pressed.

F3.1: Light curtain Icon Display

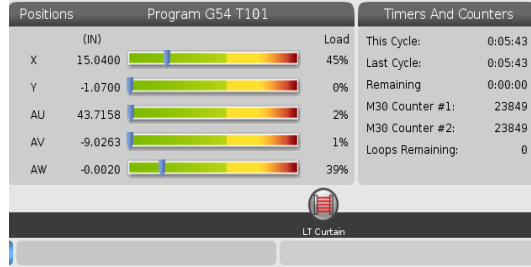

When the light curtain beam is obstructed the machine will go into a Light Curtain Hold condition and the Light Curtain icon will appear on the screen. The icon will disappear when the beam is no longer obstructed.



NOTE:

You can operate the machine in standalone mode with the light curtain disabled. But the light curtain must be enabled in order to run the APL.

3.2 Jog the APL

To jog the APL axes you need to make them visible in the Position screen.

F3.2: Axes Position Display

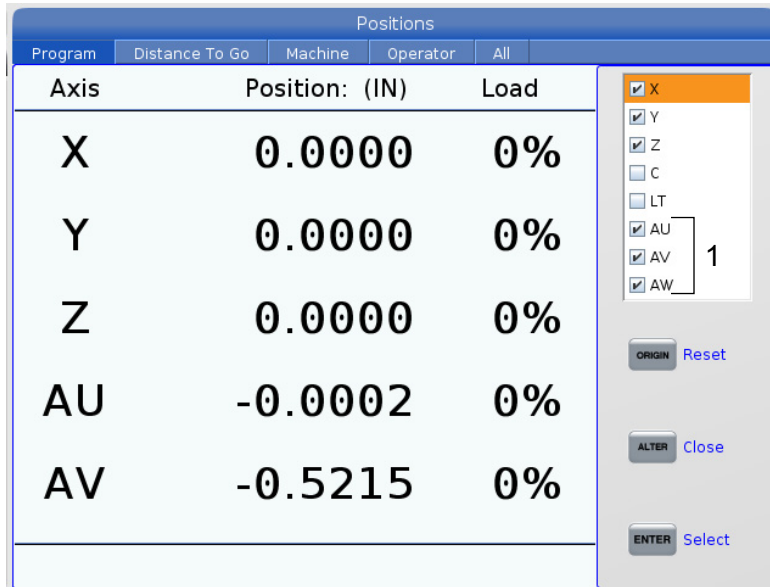

1. Press **[POSITION]**.
2. Press **[ALTER]**.
3. Select the AU, AW and AV [1] axis.
4. Press **[ALTER]** to close the pop up window.
5. To jog an APL axis. Press **[AU]**, **[AW]** or **[AV]** and then **[HANDLE JOG]**.

3.3 APL Setup

The following sections will help you set up the APL.

3.3.1 Automatic Part Loader - Template

The Template page allows to setup the grid patter and part information to run the APL.

Press **[CURRENT COMMANDS]**, **Devices**, arrow down to **Automatic Part Loader** and navigate **Template**.

F3.3: Template Display

Enter Table Grid Pattern and Part Information		
Operation	Value	Units
1 _____ Part Type	SLUG	
2 _____ Number of Stacked Parts	1	
3 _____ Number of Rows	1	
4 _____ Number of Columns	2	
5 _____ Distance Between Rows	5.2500	IN
6 _____ Distance Between Columns	5.7500	IN

Max # Parts: 2 Next

1. **Part Type** - Enter 0 for a Slug or 1 for a Bar.
2. **Number of Stacked Parts** - Enter the number of stacked parts per pocket.
3. **Number of Rows**- Enter the number of rows you want to use on the table.
4. **Numbers of Columns** - Enter the number of columns you want to use on the table.
5. **Distance Between Rows** - Enter the incremental distance between the rows.
6. **Distance Between Columns**- Enter the incremental distance between the columns.

F3.4: Stacked Parts Option Display

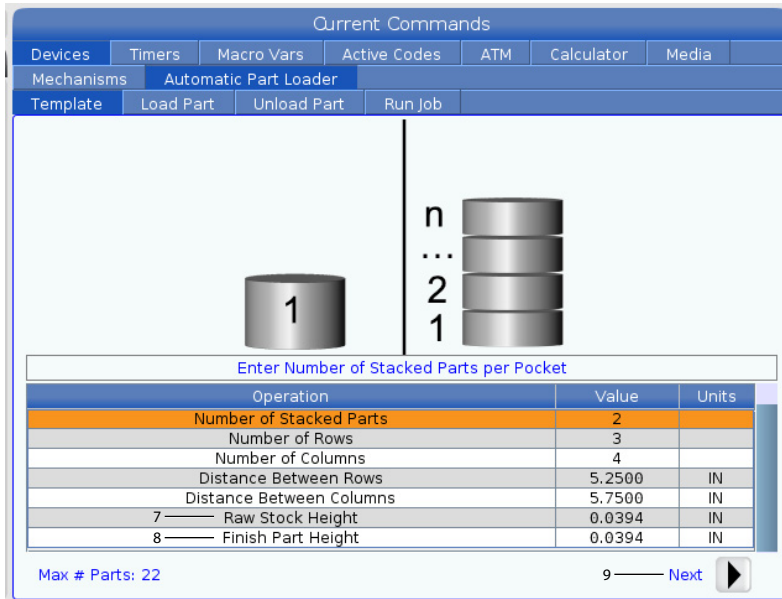

7. **Raw Stock Height** - Enter the raw stock height.



NOTE:

This option is only available when the number of stacked parts is greater than 1.

8. **Finish Part Height** - Enter the finish part height.



NOTE:

This option is only available when the number of stacked parts is greater than 1.

9. Press the **[RIGHT]** arrow to go to the next page.

3.3.2 Automatic Part Loader - Load Part

The **Load Part** page allows to setup APL Ram pick up and load position.

Press **[CURRENT COMMANDS]**, **Devices**, arrow down to **Automatic Part Loader** and navigate to **Load Part**.

F3.5: Load Part Display

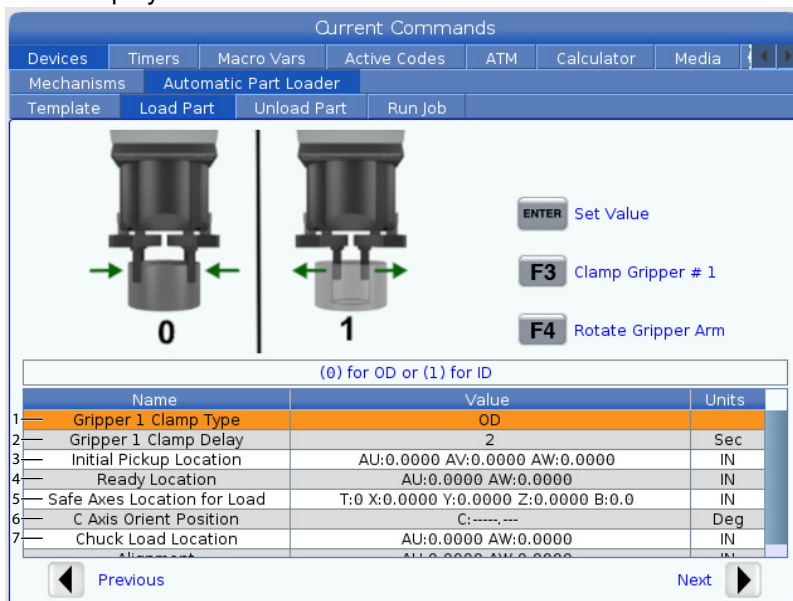

1. **Gripper Clamp Type** - Enter 0 for OD or 1 for ID clamping.
2. **Gripper Clamp Delay** - Enter the number of seconds to delay after the jaws have been commanded to move.
For the next operations the following commands are available:
 - Press **[TURRET FWD]** or **[TURRET REV]** to index the tool changer.
 - Press **[INSERT]** to move to above table.
 - Press **[F2]** to set the reference position.
 - Press **[F3]** to clamp/unclamp gripper #1.
 - Press **[F4]** to rotate the gripper arm.
3. **Initial Pickup Location** - This field is used to set the initial pickup location, follow the on screen instructions to set the values.
4. **Ready Location** - This field is used to set the position of grippers above the door, follow the on screen instructions to set the values. This location is dependent on the machine and the part. Follow the on screen instructions to set the values.



NOTE:

Jog APL to a location above the door, the RAM and part must clear door and turret.

5. **Safe Axes Location for Load** - This field is used to set the Tool Changer and Axes to a safe location for the APL to load the part. Follow the on screen instructions to set the values.



NOTE:

Machines with Y-Axis we recommend to Jog the Y-Axis about 2" in the negative direction to get maximum clearance.

6. **C Axis Orient Position** - This field is used to set the chuck orientation when loading a part. Follow the on screen instructions to set the values.
7. **Chuck Load Location** - This field is used to set the APL position to load the part into the chuck. Follow the on screen instructions to set the values.

F3.6: Load Part Display

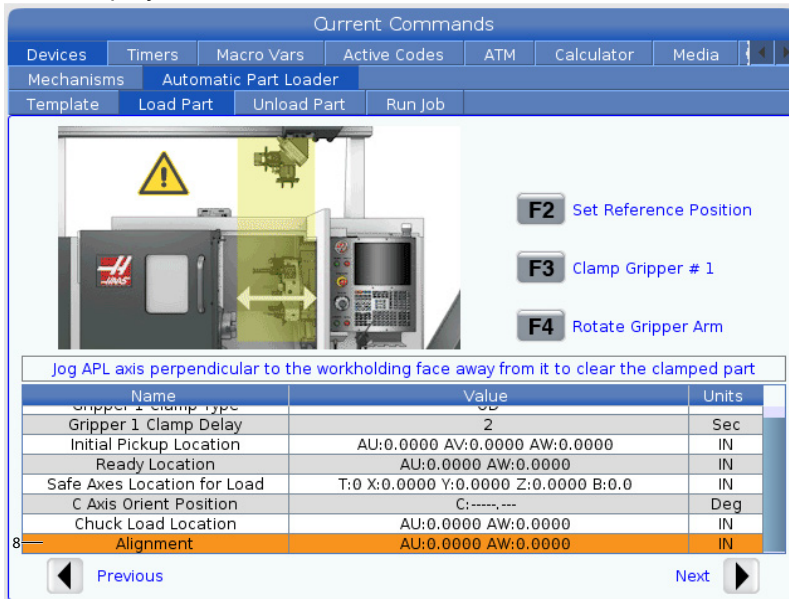

8. **Alignment** - This field is used to set the gripper location to clear the clamped part. Follow the on screen instructions to set the values.

3.3.3 Automatic Part Loader - Unload Part

The **Unload Part** page allows to setup APL Ram pick up and drop position.

Press [**CURRENT COMMANDS**], **Devices**, arrow down to **Automatic Part Loader** and navigate to **Unload Part**.

F3.7: Unload Part Display

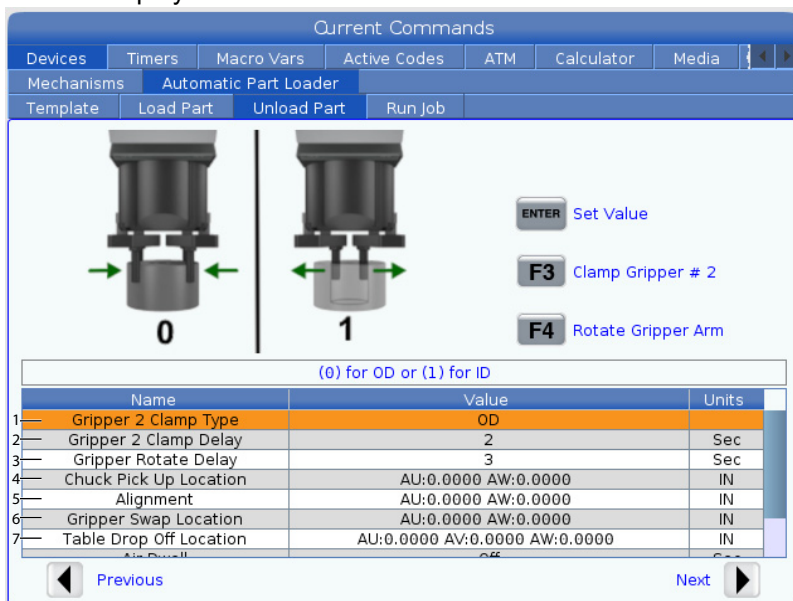

1. **Gripper 2 Clamp Type** - Enter 0 for OD or 1 for ID clamping.
2. **Gripper 2 Clamp Delay** - Enter the number of seconds to delay after the jaws have been commanded to move.
For the next operations the following commands are available:
 - Press **[TURRET FWD]** or **[TURRET REV]** to index the tool changer.
 - Press **[INSERT]** to move to above table.
 - Press **[F2]** to set the reference position.
 - Press **[F3]** to clamp/unclamp gripper #2.
 - Press **[F4]** to rotate the gripper arm.
3. **Gripper Rotate Delay** - Enter the number the seconds to delay after commanding the gripper to rotate.
4. **Chuck Pick Up Location** - This field is used to set the APL positions to pick up the part. Follow the on screen instructions to set this field.

**NOTE:**

Jog APL to a location above the door, the RAM must clear door and turret.

5. **Alignment** - This field is used to set the gripper location to clear the clamped part. Follow the on screen instructions to set the values.

6. **Gripper Swap Location** - This field is used to position the APL Grippers to a safe swap location. Follow the on screen instructions to set this field.



NOTE:

For large parts see the APL specifications section for safe gripper swap location recommendations.

7. **Table Drop Off Location** - This field is used to set the part drop off location on the table. Follow the on screen instructions to set this field.

F3.8: Air Blast Option Fields

Name	Value	Units
Gripper Rotate Delay		Sec
Chuck Pick Up Location	AU:0.0000 AW:0.0000	IN
Alignment	AU:0.0000 AV:0.0000	IN
Gripper Swap Location	AU:0.0000 AW:0.0000	IN
Table Drop Off Location	AU:0.0000 AV:0.0000 AW:0.0000	IN
8 Air Dwell	Off	Sec
9 Chuck Rotation Speed	Off	RPM
10 Chuck Clamp Delay Time	2	Sec

8. **Air Dwell**- Enter the number of seconds to turn on the spindle air blast after the part has been removed.



NOTE:

This field will only show if the machine is equipped with the air blast option.

9. **Chuck Rotation Speed** - Enter the speed at which the spindle will turn during air blast.



NOTE:

This field will only show if the machine is equipped with the air blast option.

10. **Chuck Clamp Delay Time** - Enter the dwell time before the APL gripper releases the part.
11. Press the **[RIGHT]** arrow to go to the next page.

3.3.4 Automatic Part Loader - APL Mode - Save/Load/New Job

The **Run Job** tab allows you to load/run and save a job. It also shows the current APL mode status.

F3.9: Run Job Display

2	Current Part	0
3	Next Part	1
4	Completed Parts	5
5	Total Parts	2
6	Rapid Override	100%
7	Slow Rapid Distance	0.5 IN
8	Slow Rapid Override	20%
9	Current State	IDLE_STATE

1. This tab shows the current job that the APL is running.



NOTE:

The Job file name will turn red if the job is not saved.

How to Save the current Job Once you have completed filling in the values on the Template, Load Bar and Load Part tabs.

- Type in the desired job name on the input bar.
- Press **[F3]**. Select the location where you want to save the file.
- Press **[ENTER]** to save the file.



NOTE:

The job file is a XML file.

How to Load a Job To load a previous job:

- Press **[F4]** to load a job.
- Find and highlight the job XML file you wish to load.
- Press **[ENTER]** to load the file.

How to Start a New Job To start a new job:

- Press **[F2]**.
- A popup window will show “Are you sure you want to clear?”
- Press **[Y]**.



NOTE:

This will reset the values in the Template, Load Part, Unload Part etc. back to factory values.

2. **Current Part**- This field can be updated so that the sequence will start at this point.
3. **Next Part** - This counter shows the next part.
4. **Completed Parts** - This counter shows the amount of completed parts. This field can be reset with **[ORIGIN]**.
5. **Total Parts** - This field can be changed. The sequence will run until total parts = completed parts. This would allow of running of a partial table.
6. **Rapid Override** - This shows the current rapid override status.
7. **Slow Rapid Distance** - When the APL is this distance from picking up or dropping off a part (either from table or spindle) the speed will drop to the Slow Rapid Override setting.
8. **Slow Rapid Override** - When the APL is the Slow rapid distance from picking up or dropping off a part (either from table or spindle) the speed will drop to this setting.
9. **Current State** - This shows the APL current state.

APL Mode

F3.10: APL Mode Display

The screenshot displays the CNC control interface in APL Mode. The main display area shows "APL Mode" in large blue letters. A callout line labeled "11" points to this text. On the right, a "Current Commands" window shows "Job: APlSetup.xml **" with a table of part statistics and four colored circles (two green, two yellow). Below this, a "Recovery" button is labeled "10". At the bottom, a "Main Spindle" section shows a "STOP" button and "Overrides" for Feed, Spindle, and Rapid. A "Positions" section shows coordinates for X, Y, AU, AV, and AW. A "Timers And Counters" section shows cycle and remaining times. At the bottom, a "Setup" button and an "APL Mode" icon are visible.

Current Part	Next Part	Completed Parts	Total Parts	Rapid Override	Slow Rapid Distance	Slow Rapid Override	Current State
4	5	3	4	75%	5.0 IN	25%	IDLE STATE

Positions	Program G54 T101	Load	Timers And Counters
X	15.0400	45%	This Cycle: 0:05:43
Y	-1.0700	0%	Last Cycle: 0:05:43
AU	43.7158	2%	Remaining: 0:00:00
AV	-9.0263	1%	M30 Counter #1: 23849
AW	-0.0020	39%	M30 Counter #2: 23849
			Loops Remaining: 0

10. Press **[INSERT]** to turn ON/OFF the **APL Mode**. When the machine is in **APL Mode** the control will load the next part when the machine executes an **M299** code. Refer to "M299 APL / Part Load / or Program End" on page 25 for more information. Refer to M299 APL / Part Load / or Program End for more information.
11. The **APL Mode** overlay and **APL Mode** icon appear on the screen when the machine is in APL mode.



NOTE:

APL Mode is canceled when the power is cycle, you will need to turn it back on if you need to use it.

3.4 APL Recovery

If the Automatic Part Loader cycles get interrupted you must enter **[RECOVER]** mode to correct or complete the cycle.

Press the **[RECOVER]**, the recovery page will display the Chuck, Gripper, status.

F3.11: Automatic Part Loader Recovery Display: APL Functions [1], APL status [2], Message Box [3].

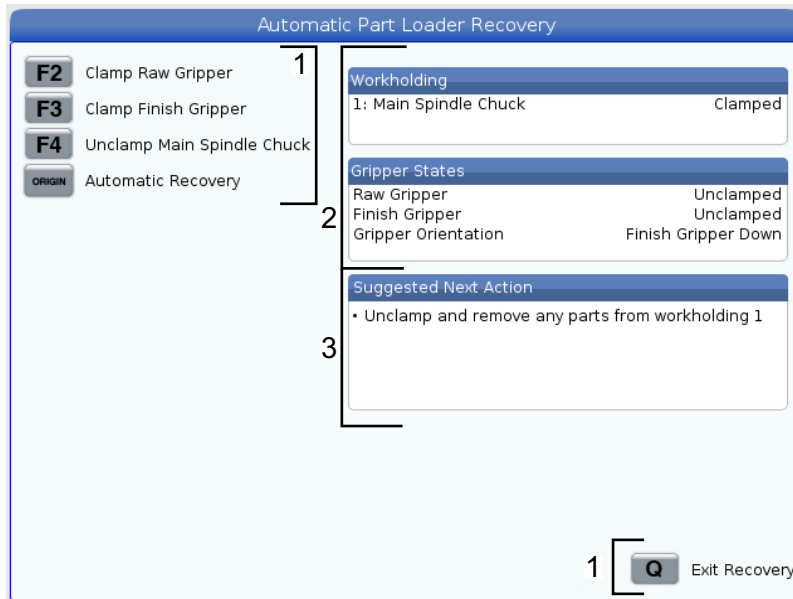

[F2] Clamp Raw Gripper. This will clamp the raw gripper.

[F3] Clamp Finish Gripper. This will clamp the finish gripper.

[F4] Unclamp Main Spindle Chuck. This will unclamp the main spindle chuck.

[ORIGIN] Automatic Recovery. This will attempt to recover the APL automatically.

[Q] Exit Recovery. This will exit the APL recovery display.

Chapter 4: APL Programming

4.1 M299 APL / Part Load / or Program End

During APL mode, use a M299 instead of an M30 at to have the APL load parts automatically. Refer to the APL set up section.

When not running in APL mode the M299 takes the place of an M30 or M99 at the end of a program.

Also when running in Memory or MDI mode, pressing **[CYCLE START]** to run the program, the M299 will behave the same as an M30. It will stop and rewind the program back to the beginning.

F4.1: APL Mode screen

To run in APL mode, Press **[CURRENT COMMANDS]**, navigate to **Devices**, arrow to **Automatic Parts Loader** and navigate to **Job Run** tab.

Press **INSERT** to put run a program in APL Mode.

The following is a example of a program using the M299 code:

```

%
o00010 (APL LOAD UNLOAD);
G00 G53 X0 Y0 Z0;
T101;
M19 P90.;
G54;
G00 Z1.5;
X0.;
G98;
G01 Z-0.5 F50.;
G04 P1.;
M11;
M10;
G04 P1.;
M11;
M10;
G04 P1.;
G00 Z1.5;
G00 G53 X0. Y0.;
G00 G53 Z0;
M299 (PART SWAP);
%
```

4.2 Plunger Programming

The first part of the machining program must be an operation to seat the SLUG properly on the Jaws shoulder or stop. The Haas supplied spring plunger can be used or any custom made tool. The Plunger like any tool must have it's own tool offset and station on the turret.

To run in APL mode, Press **[CURRENT COMMANDS]**, navigate to **Devices**, arrow to **Automatic Parts Loader** and navigate to **Job Run** tab.

Press **INSERT** to put run a program in APL Mode.

The following is a example of a program using the plunger to seat a part in the jaws:

```
%O00010 (APL SPRING PLUNGER SECTION
(PN 30-12642)
(SAFETY LINE BELOW)
G00 G54 G18 G40 G80 G97 G99;
T0101;(SPRING PLUNGER TOOL)
G54;
G00 Z2.;
X0.;
G98;(INCH PER MINUTE FEED)
G01 Z0.25 F75.0;
Z-0.25 F40.0;
M11;(CHUCK OPEN)
G04 P0.5;
M10;(CHUCK CLOSE)
G04 P0.5;
G00 Z2.;
G00 G53 X0. Y0.;
M01;%
```

1. Approach part in rapid motion and stop approximately 0.25" (6 mm) from the part.
2. Feed in and push plunger against the part until spring has compressed ½" (12 mm).
3. Open and Close the chuck using M11 and M10 for part to seat.
4. Retract away from the part in Rapid motion and proceed with machining process

4.3 APL Stop/Resume Feature

This feature lets you stop (interrupt) a running part program during an Automatic Part Loading cycle (APL Mode) and then resume normal operation from any part in the program. The APL will not lose part count and it will continue the part load and unload cycle.



NOTE:

1. The part program must be stopped with any program stop command (M00,M01,M02,M30).
2. The APL must reach the “At Ready” position before hitting reset.
3. Do not take the control out of “APL Mode”.

After resetting the control an operator may switch to MDI mode, EDIT mode, JOG Mode to do any changes or part inspections as needed. All operation is normal at this point.

When the operator is ready to resume Part Machining in APL Mode. Press **[MEMORY]** and then put the cursor on the Tool Callout (e.g. T0505) where you want the program to start from. DO not start in the middle of the program since this may cause unintended motion.

With the control still in APL Mode press **[CYCLE START]** and resume part machining and APL operation.

Chapter 5: APL Maintenance

5.1 APL Maintenance

Keep your APL running at peak performance while avoiding unplanned downtime. A maintenance program allows you to manage your schedule rather than getting caught with untimely surprises. This page shows the recommended maintenance intervals.

Maintenance Item	Interval
Grease the AW axes rollers.	Six Months

Index

A	
APL	
APL Enable	13
APL Mode	25, 27
Maintenance	29
Overview.....	2
APL Recovery	24
APL Setup	
APL mode	21
Load Part	16
Run Job	21
Template.....	15
Unload Part	18
H	
How to	
load a job	22
save current job	21
start a new job	22
I	
installation	11

